

AM 114ID

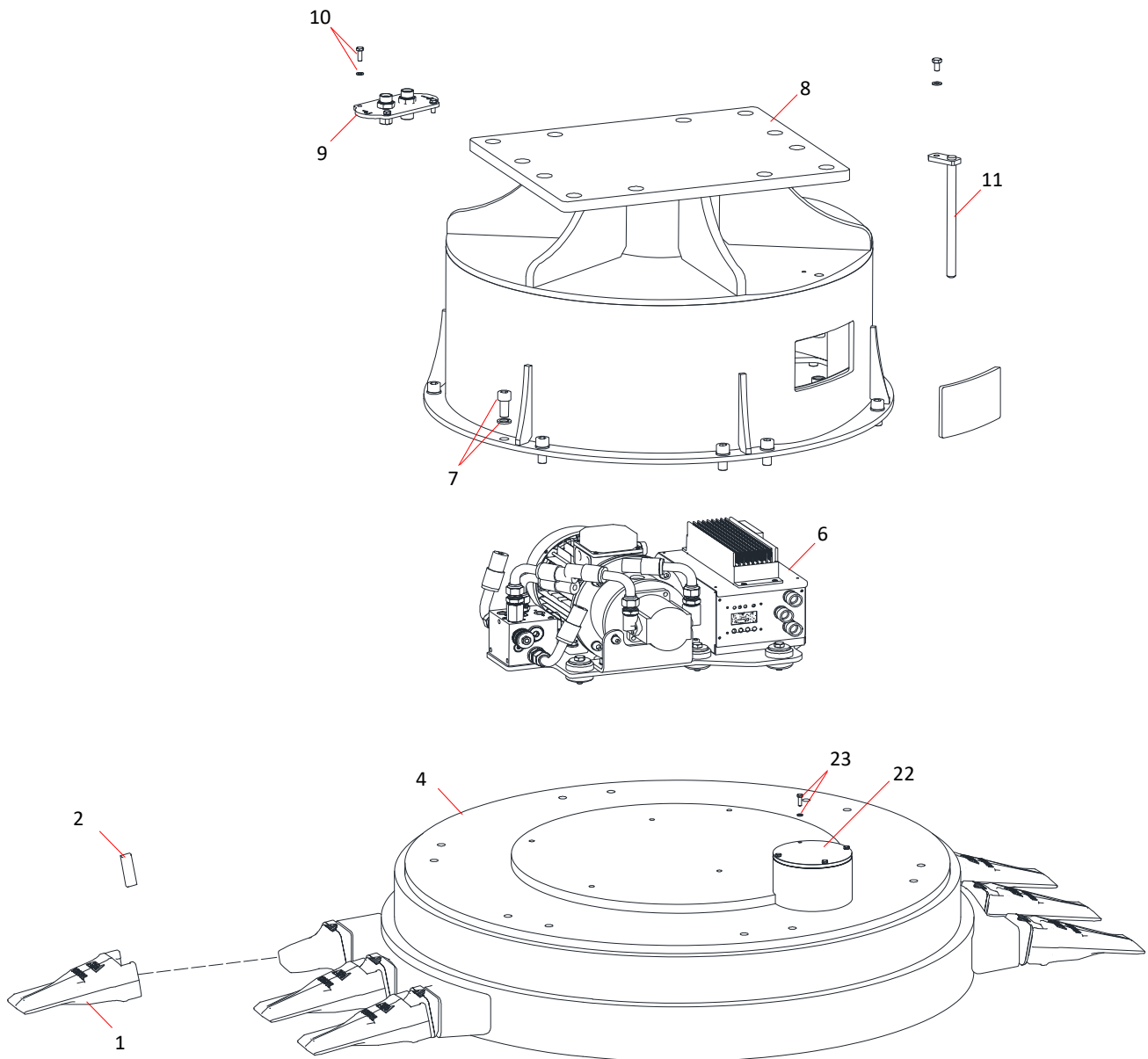

POS.	Q,TY	PART No.	DESCRIPTION
1	6	DPT001_ESC	TEETH TIP
2	6	SP_ESC	TEETH PIN
4	1	BASE02D114 (E)	MAGNETIC BASE WITH TEETH (E)
6	1	GCM01A04	HYDRAULIC GENERATOR SET
7	1	KIT114V001	COVER SCREWS - SET OF 12
8	1	COP002P	MAGNET COVER WITH ATIB2000 PLATE
9	1	PSP-007-PT	PASS THROUGH PLATE
10	1	KIT114V002	PASS THROUGH PLATE SCREWS - SET OF 4
11	1	PRN_COP	COVER PIN
22	1	COP_U.C	CONNECTION SOCKET CAP
23	1	KIT114V003	SCREWS OF CONNECTION SOCKET CAP - SET OF 4